



Long-lasting and low maintenance, LED-based light sources are an excellent solution for all lighting applications. For optimal performance, these solutions require reliable drivers matching the long lifetime of the LEDs. **The Advance Xitanium LED outdoor driver portfolio** offers a range of products specially designed to operate LED solutions in outdoor applications. These drivers are designed for hard-wired integration into outdoor luminaires for the most rugged applications. They operate to specification under wide temperature and electrical ranges to ensure reliability.

Specifications

Input Voltage (Vac)	Output Power (W)	Output Voltage (V)	Output Current (A)	Efficiency @ Max Load and 70°C Case	Max Case Temp. (°C)	Input Current (A)	Max. Input Power (W)	THD @ Max Load (%)	Power Factor @ Max Load	Surge Protection (Combi-Wave, KV)	Envir. Protect. Rating	Dimming	Dimming Range (with specified dimmers)	Min. Output Current (A)	Driver Type
347	180	70 - 210	0.1 - 1.25	92.5	Life - 85°C UL - 90°C	0.55	200	<10%	>0.95	6	UL damp & dry and Type HL	0-10V Analog Class 1 and 2 Wiring	10% - 100%	0.07	Constant Current
480				93		0.4									

Enclosure

	In. (mm)	Tolerance (mm)
Overall Length (A1)	9.47 (240.5)	± 0.5
Mounting Length (A2)	8.91 (226.2)	± 0.5
Case Length (A3)	8.31 (211)	± 0.5
Case Width (B1)	2.31 (58.6)	± 0.5
Mounting Width (B2)	1.69 (42.9)	± 0.5
Case Height (C1)	1.48 (37.6)	± 1.0
Mounting Hole Diameter (D1)	0.23 (5.9)	± 0.5
Mounting Hole Diameter (D2)	0.31 (7.9)	± 0.5
Center of SimpleSet Antenna (G1)	3.77 (95.8)	± 3.0

Wiring Diagram

	Wire Length (mm)
Black/Orange (Line)	270 (± 30)
Black/White (Neutral)	270 (± 30)
Red (Positive, LED output)	270 (± 30)
Blue (Negative, LED output)	270 (± 30)
Violet (Positive, 0-10V)	270 (± 30)
Pink (Negative, 0-10V)	270 (± 30)

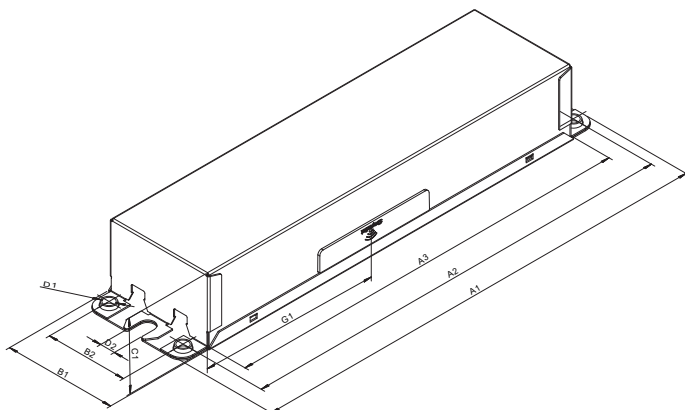

o))) SimpleSet

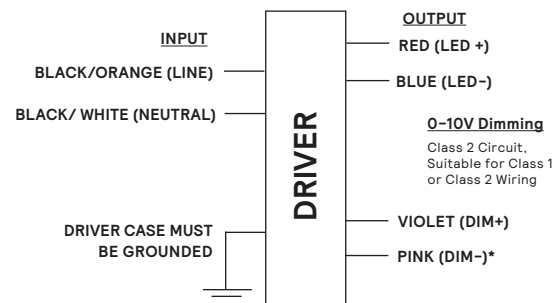

*DIM- will change from GREY to PINK from 2021 onwards.

Warning

- Install in accordance with national and local electrical codes.
- The field-wiring leads or push-in terminals shall be enclosed.



Xitanium XH180C125V200BSF2

180W 0.1-1.25A 0-10V Dimming

Features

- 50,000+ hour lifetime¹
- Excellent thermal performance
- 0-10V Dimming suitable for UL Class 1 and Class 2 wiring

Benefits

- Enables long life luminaire designs
- Allows luminaire designs for a wide range of ambient environments

Application

- Area
- Roadway
- Parking garages
- Floodlights

Electrical Specifications

All the specifications are typical and at 25°C Ta unless specified otherwise.

Product Data

Order Information	
Full Product Code	XH180C125V200BSF2M (Mid-Pack, 10pcs/Box), 12NC: 929001783113
Line Frequency	50/60Hz
Min. Mains Voltage Operational	312 Vac
Max. Mains Voltage Operational	528 Vac
Output Information	
Maximum Open Circuit Voltage	290Vdc
Output Current Ripple (ripple = peak to average / average)	15% max @ max lout (Low frequency ripple (≤120Hz) content <5%)
Output Current Tolerance (at maximum output current)	<5%
Protections	Short Circuit, Open Circuit Protection for LED + and LED - and Temperature Foldback
Features	
0-10V Dimming	150µA (±3%) source current from driver. See dim curve for detail.
AOC (Adjustable Output Current)	0.1A-1.25A via SimpleSet (Factory Default at 0.7A)
Environment & Approbation	
Operating Ambient Temp. Range	-40°C to +55°C
Max Case Temperature (Tcase)	85°C for Life and 90°C for UL Safety
Agency Approbations	UL 8750, NOM, cUL, Class P (UL, cUL)
Electromagnetic Compliance	FCC Title 47 Part 15 Class A
Audible Noise	<24dB Class A
Weight	2.1 Lbs / 0.95 kgs

1. Advance Xitanium LED Drivers are manufactured to engineering standards correlating to a designed and average life expectancy of 50,000 hours of operation at maximum rated case temperature. Minimum 90% survivals based on MTTF modeling.

Xitanium XH180C125V200BSF2

180W 0.1-1.25A 0-10V Dimming

Electrical Specifications

All the specifications are typical and at 25°C Ta unless specified otherwise.

0-10V Dimming Curve

Dimming source current from the driver: 150µA (@ 0<Vdim<8V)

Minimum dim level: 10% of lout setting as default

Maximum output voltage on the dimming wires: 12V

Leakage current of dimming leads: 0.042 mA, recommended max number of control circuits in parallel refer to Design-in Guide

Approved Dimmer List

Manufacturer	Manufacturer Part Number
Lutron	Visit www.lutron.com/advance for a list of dimmers (Mark VII) that will work with this driver
Leviton	IllumaTech IP7 series
Advance	Sunrise - SR1200ZTUNV

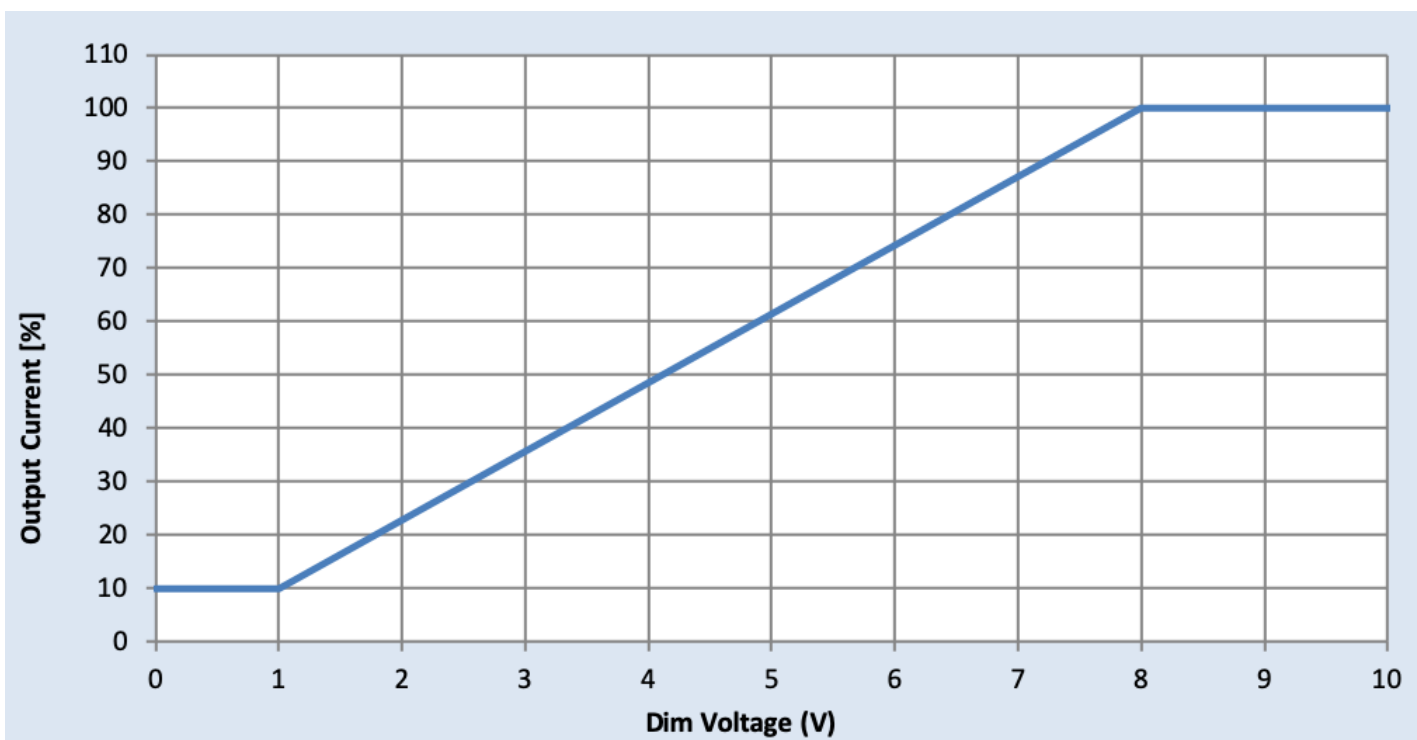

Xitanium XH180C125V200BSF2

180W 0.1-1.25A 0-10V Dimming

Electrical Specifications

All the specifications are typical and at 25°C Ta unless specified otherwise.

Driver Output Window

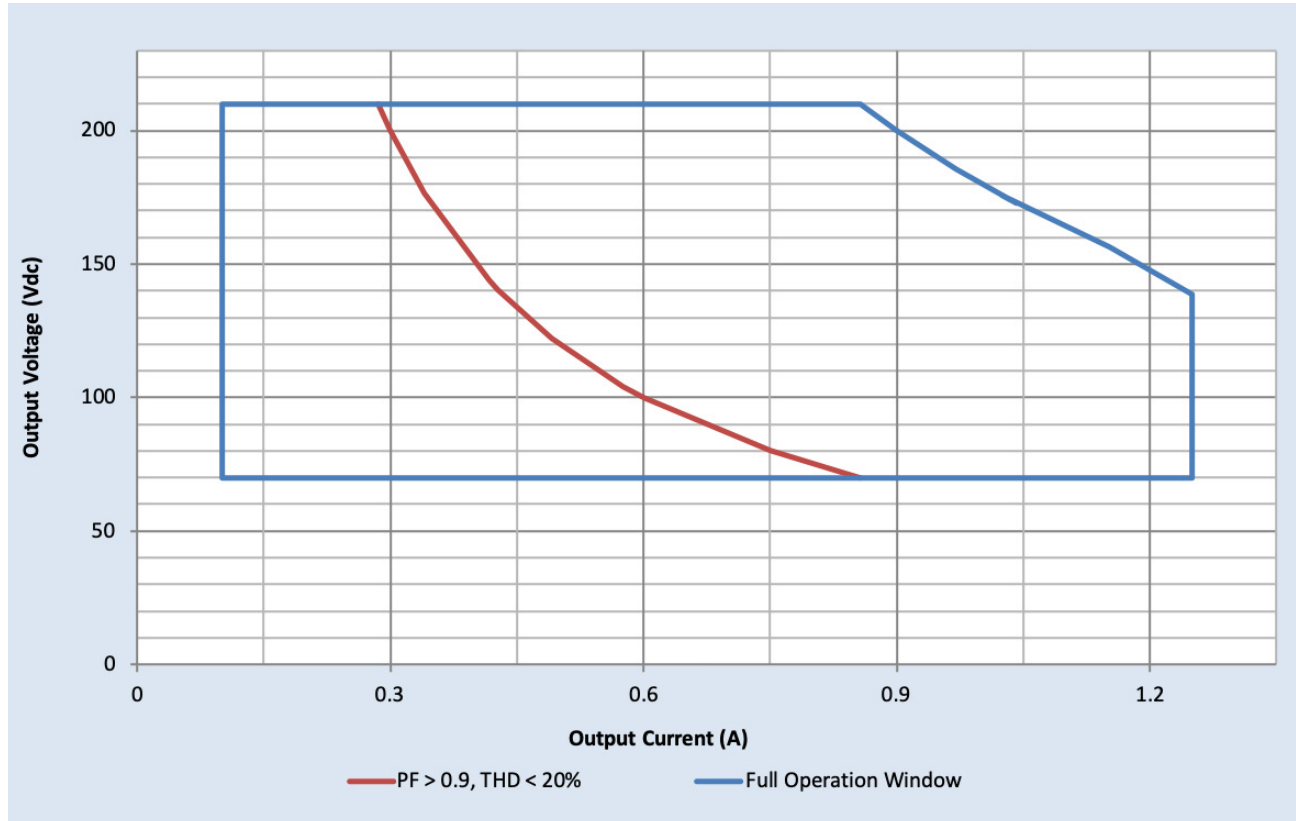

Notes

1. Factory default output current is 1.05A.
2. To get a 100% to 10% dimming range, the output current setting through AOC should be $\geq 0.7A$.
3. Factory default minimum dimming level is 10%. This can be adjusted between 10% and 100% using Advance MultiOne.

Xitanium XH180C125V200BSF2

180W 0.1-1.25A 0-10V Dimming

Electrical Specifications

All the specifications are typical and at 25°C Ta unless specified otherwise.

Output Current Vs. Driver Case Temperature

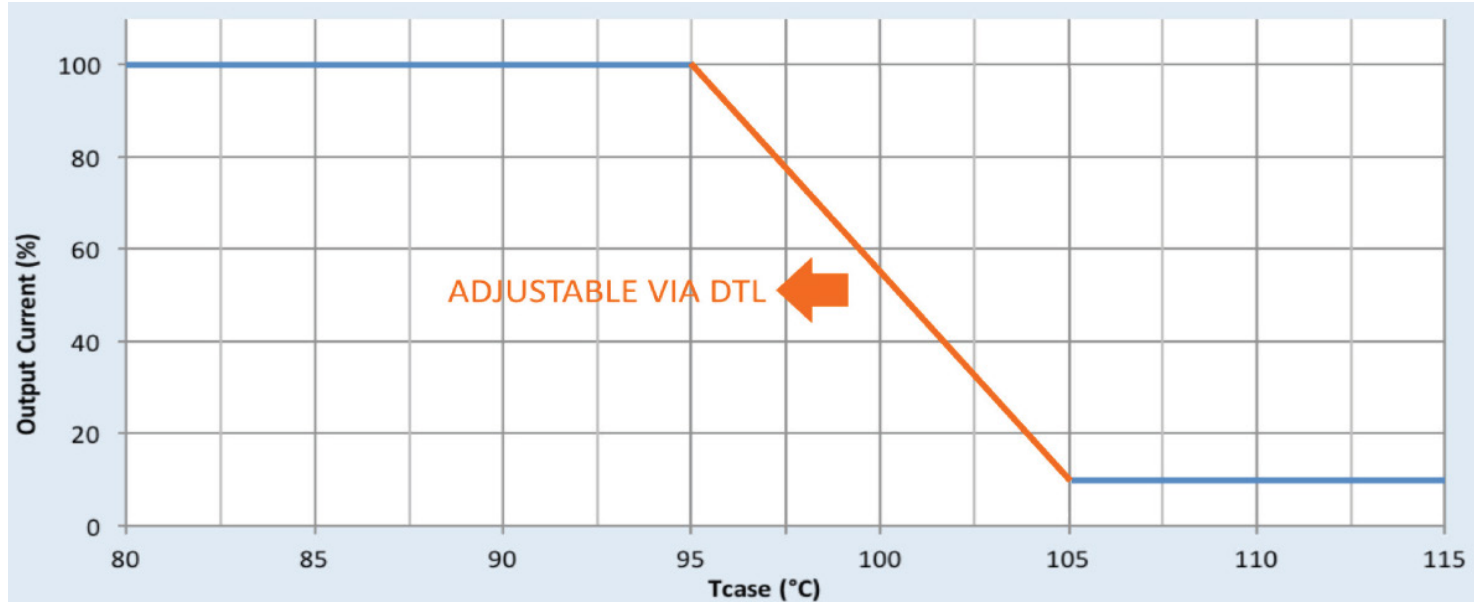

Note

There is $\pm 5^\circ\text{C}$ tolerance on the driver case temperature.

Driver Lifetime Vs. Driver Case Temperature

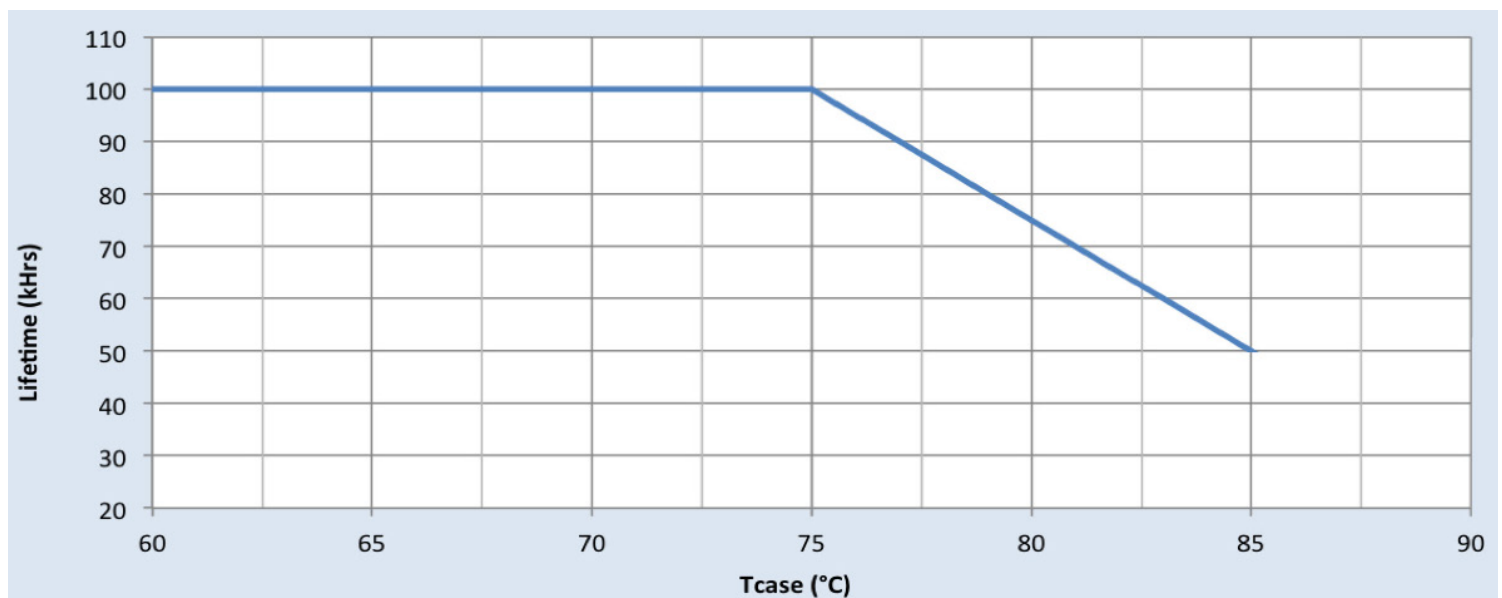

Xitanium XH180C125V200BSF2

180W 0.1-1.25A 0-10V Dimming

Performance Characteristics

Based on measurements on a typical sample at 70°C case. The accuracy of the measurements is within the tolerance of the measurement instruments.

Efficiency Vs. Output Voltage at 347Vac

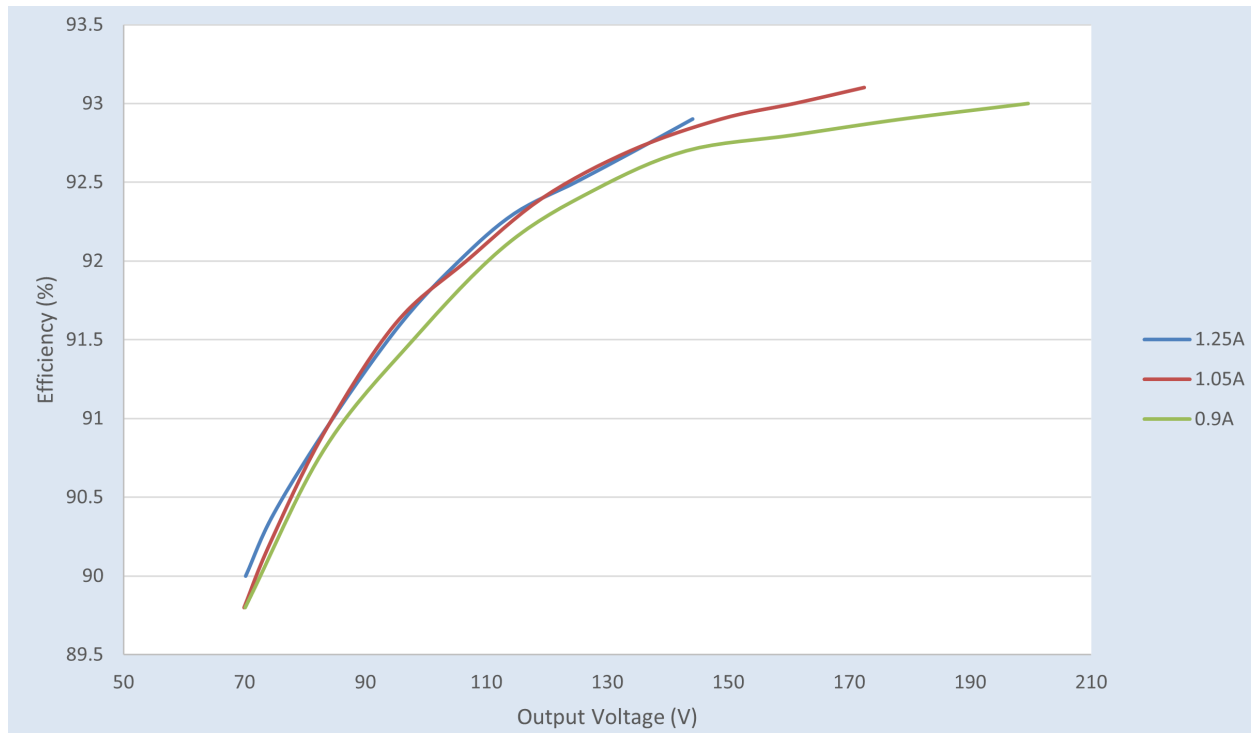

Efficiency Vs. Output Voltage at 480Vac

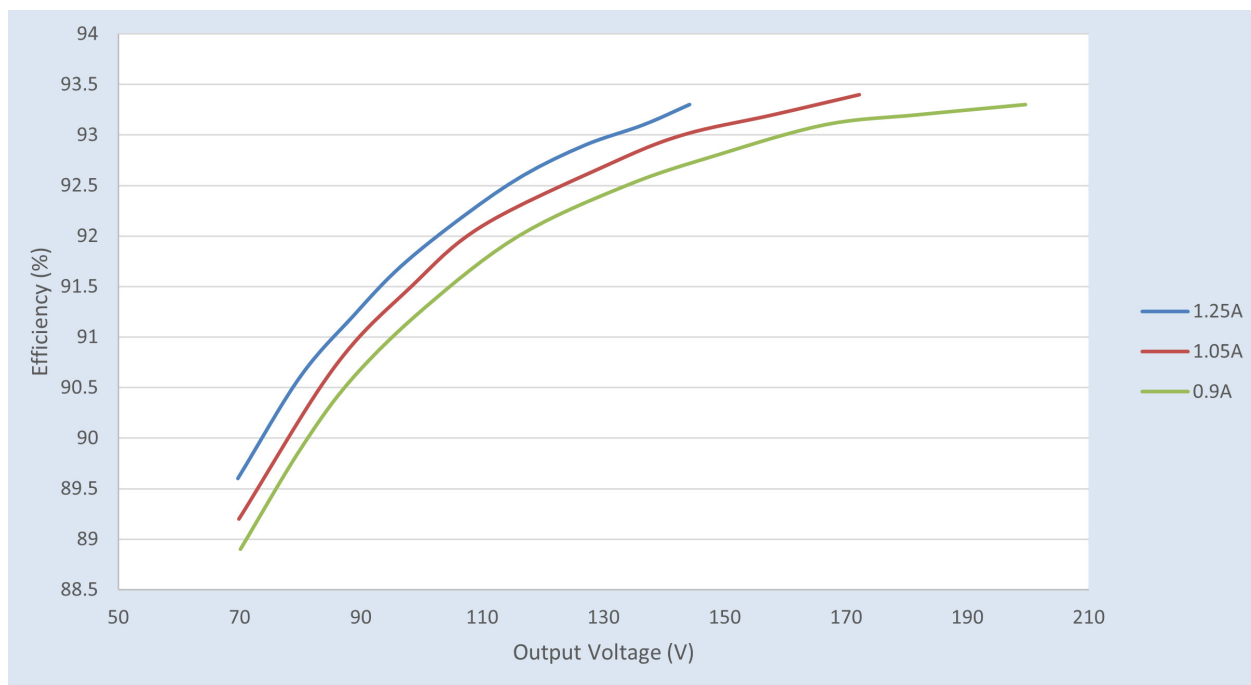

Xitanium XH180C125V200BSF2

180W 0.1-1.25A 0-10V Dimming

Performance Characteristics

Based on measurements on a typical sample at 70°C case. The accuracy of the measurements is within the tolerance of the measurement instruments.

Power Factor Vs. Output Power

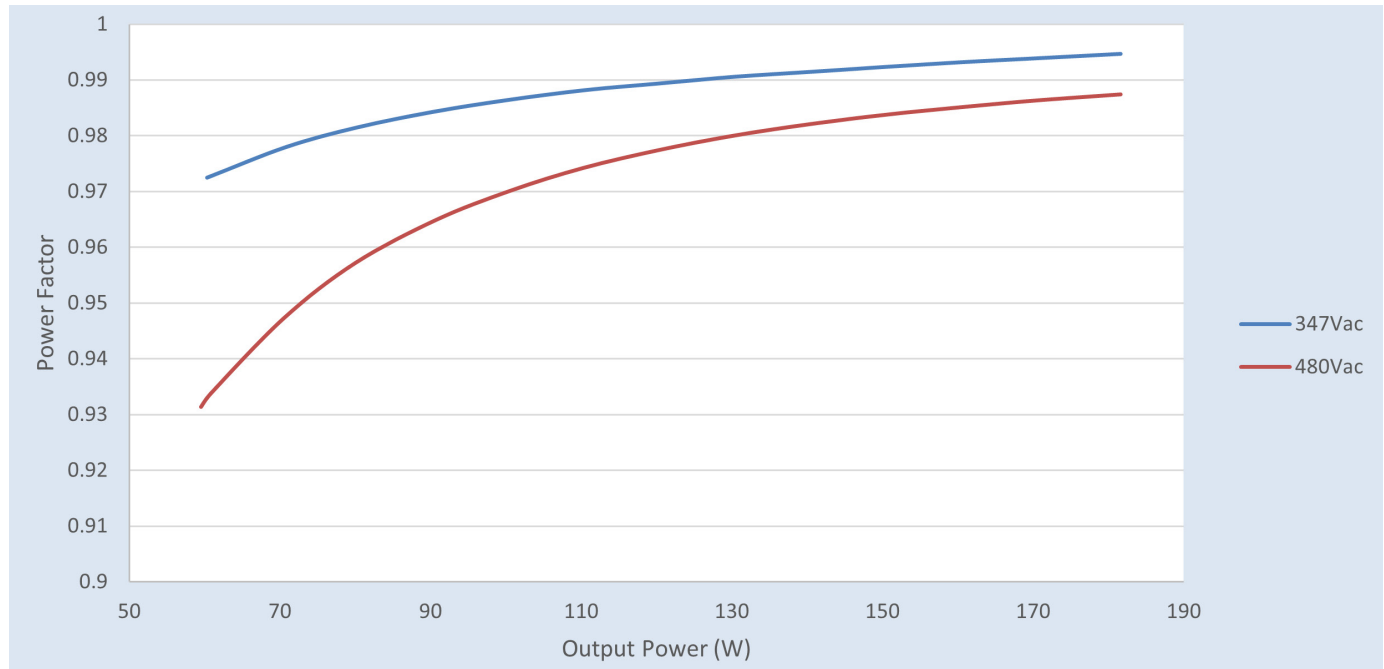

Total Harmonic Distortion (THD) Vs. Output Power

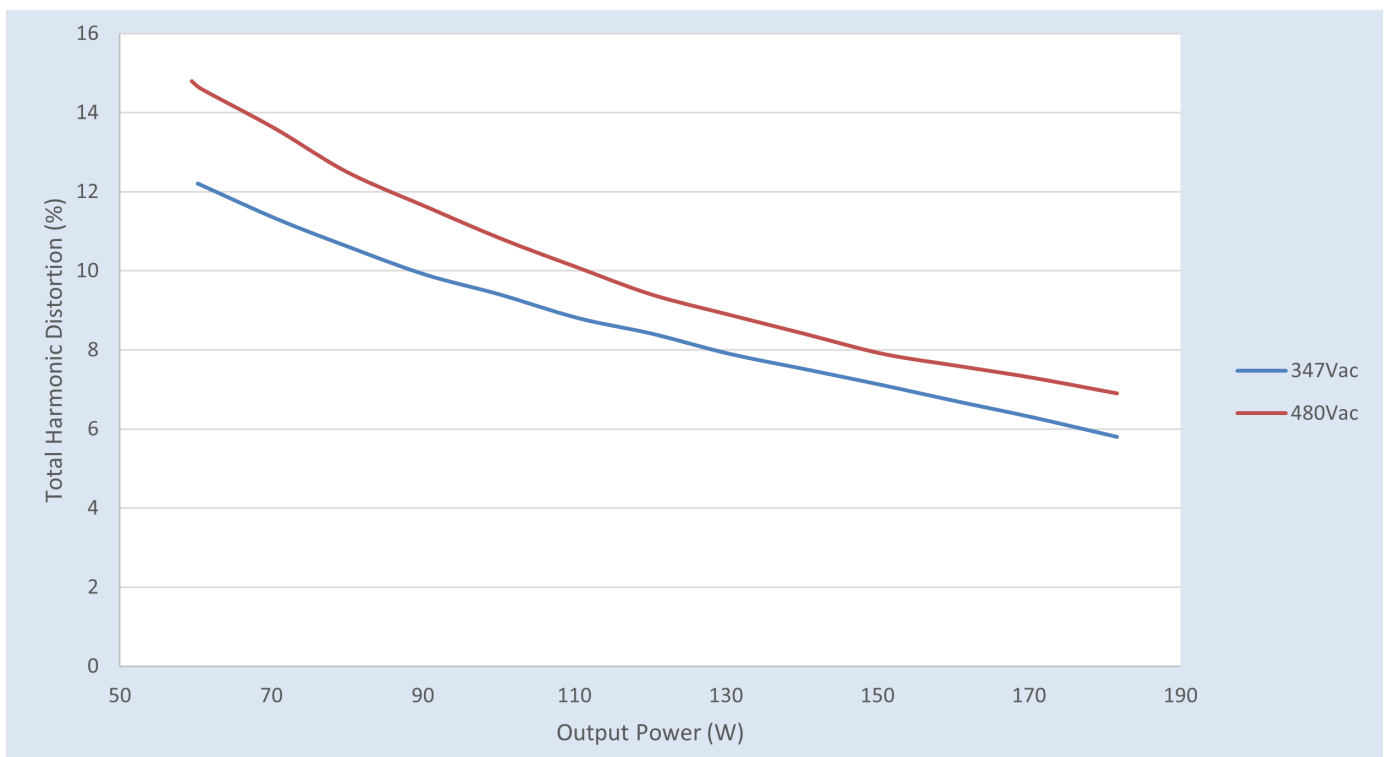

Xitanium XH180C125V200BSF2

180W 0.1-1.25A 0-10V Dimming

Inrush Current Info

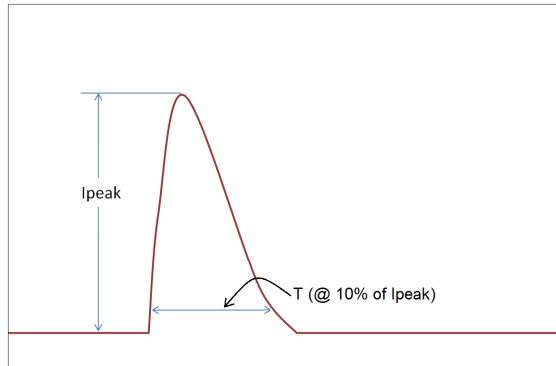

Vin	Ipeak	T (@ 10% of Ipeak)
347 Vrms	59.6A	231μS
480 Vrms	82A	229μS

Inrush current is measured at peak of the corresponding line voltage. Source impedance per NEMA 410.

Lightning Surge Info

ANSI Surge Type	Differential Mode (L-N)	Common Mode (L-G, N-G, L&N-G)
Combination Wave (w/t 2Ω)	6kV	6kV

Isolation

Isolation	Input	Output	0-10V	Enclosure
Input	NA	2xU+1kV	2.5kV	2xU+1kV
Output	2xU+1kV	NA	2.5kV	2xU+1kV
0-10V	2.5kV	2.5kV	NA	2xU+1kV
Enclosure	2xU+1kV	2xU+1kV	2xU+1kV	NA

U = Max input voltage

The information presented in this document is not intended as any commercial offer and does not form part of any quotation or contract.



© 2022 Signify Holding. All rights reserved. The information provided herein is subject to change, without notice. Signify does not give any representation or warranty as to the accuracy or completeness of the information included herein and shall not be liable for any action in reliance thereon. The information presented in this document is not intended as any commercial offer and does not form part of any quotation or contract, unless otherwise agreed by Signify.

Signify North America Corporation
400 Crossing Blvd, Suite 600
Bridgewater, NJ 08807
Telephone: 855-486-2216

Signify Canada Ltd.
281 Hillmount Road,
Markham, ON, Canada L6C 2S3
Telephone: 800-668-9008

All trademarks are owned by Signify Holding or their respective owners.