



The Xitanium SR LED Driver can help reduce complexity and cost of light fixtures used in wireless connected lighting systems. It features a standard digital interface to enable direct connection to any suitably qualified RF sensor on the market. Functionality is integrated into the SR driver that ordinarily would require additional auxiliary components. The result is a simpler, less expensive light fixture that can enable every fixture to become a wireless node.

### Specifications

Input Voltage (Vrms)	Output Power (W)	Output Voltage (V)	Output Current (A)	Efficiency @ Max Load	Max. Case Temp. (°C)	Input Current (Arms)	Max. Input Power (W)	Inrush Current (A <sub>pk</sub> /10%-µs)	THD @ Max. Load	Power Factor @ Max. Load	Surge Protection Common/Diff (KV)	Weight (Lbs/kgs)	Envir. Protection Rating
120	40	27 ~ 54	0.10 – 1.1	>85%	Life 75 °C UL 85 °C	0.40	47	22/191	<10%	>0.95	2.5/2.5	0.70/0.32	UL Dry & Damp
277				>87%		0.17		52/183	<15%				

### Enclosure

	In. (mm)
Case Length	14.17 (360)
Case Width	1.18 (30)
Case Height	1.0 (25.4)
Mounting Length	13.78 (350)
Overall Length	14.17 (360)

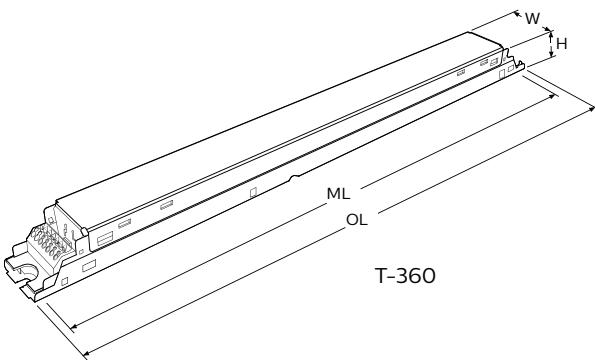

### Wiring Diagram

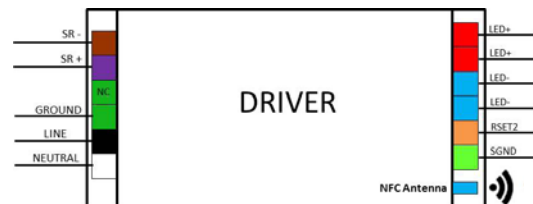

Both output positive and negative connectors are equivalent (same electrical point).

Input and output use WAGO 250 connectors.

#### Connect wires:

Use 18 AWG Solid Copper Wire  
Rated  $\geq 300V$ .  
Strip Wire 3/8".

Dimming Method	Dimming Range	Minimum Output Current (A)
DALI	5% ~ 100% (for output current range 0.25-1.1A)	0.0125

# XITANIUM SR XI040C110V054VPT1

## 40W 0.10-1.1A 54V SR

### Features

- Standard digital interface based on DALI 2.0 for connection of one driver to one sensing/ RF device
- Auxiliary power for sensors through digital connection, default "on" for connection to single sensing/RF device
- Occupancy and accurate energy reporting
- Dim-to-off capability
- Low standby power (<1W)

- Drive current setting via SimpleSet wireless programming or Rset2
- 5-year limited warranty\*

### Benefits

- Enable wireless interoperability with multiple sensors/network systems
- Reduce complexity and cost of fixture by eliminating auxiliary components ordinarily required for powering sensors, switching fixture off and monitoring energy use

- Future proof through standard interface to any suitable sensor and ease of adjustable drive current

### Application

- Indoor linear applications such as troffers and pendants

### Product Data

All specifications are typical and at 25°C Tcase unless otherwise specified.

Ordering Information	
Order Code	XI040C110V054VPT1
Full Product Code	XI040C110V054VPT1M (Mid-pack, 18/box)
Full Product Name	XITANIUM 40W 0.10-1.1A 54V 120-277V SR
Net Weight Per Piece	0.32 KG / 0.70 lbs
Input Information	
Inrush Current	Per NEMA 410
Line Voltage (AC Operation)	120-277VAC +/- 10%
Line Current	0.40A @ 120V, 0.17A @ 277V
Line Frequency	50/60Hz
Output Information	
Output Voltage Range	27VDC to 54VDC
Output Current Ripple	<15% at max lout (ripple = pk-avg/avg) Low frequency (<120 Hz) content <5%
Output Current Tolerance	±5% at max output current
Open Circuit Voltage	60V
Protections	Short Circuit and Open Circuit Protection for LED + and LED-, mis-wiring protection
Features	
AOC (Adjustable Output Current)	100mA to 1100mA via external resistor or SimpleSet programming (refer to graphs and notes)
Life @ TC 75°C	50000 hr [nom] (refer to graphs)
Suitable for Outdoor Use?	No
Interfaces	AOC (RSET2 or SimpleSet), SR (DALI 2.0)
Ambient Temp Range	-20°C to +50°C
Max Case Temperature (Tcase)	85°C for UL, 75°C for life
Input Over-voltage	Can survive input over-voltage stress of 320VAC for 48 hours and 350VAC for 2 hours
Earth Leakage Current	0.75 mA [max]
THD Total	Refer to graph
Power Factor	Refer to graph
SR Interface	DALI 2.0
Sensor Power Supply	52-60mA (55mA typ.); 12vdc-20vdc (14vdc typ.) (refer to graph)
Power Reporting Accuracy	±0.5W/±4%
Environment & Approbation	
Agency Approbations	UL8750, UL1310, UL935, CSA-C22.2 No. 250.13-12, CSA C22.2 No. 223
Audible Noise	<24dB Class A
Isolation Between Output and Input	Refer to table
Isolation of Controls	Refer to table
EMC (Electromagnetic Compliance)	Meets FCC 47 Part 15 Class A
Envir. Protection Rating	UL Dry & Damp

\* View limited warranty: [http://www.usa.lighting.philips.com/connect/tools\\_literature/warranties.wpd](http://www.usa.lighting.philips.com/connect/tools_literature/warranties.wpd)

# XITANIUM SR XI040C110V054VPT1

40W 0.10-1.1A 54V SR

## Electrical Specifications

All the specifications are typical and at 25°C Tcase unless specified otherwise.

## Adjustable Output Current (AOC) Info

LED current tolerance with variation of Rset2 is within  $\pm 5\%$  of Imax.

Rset (Ohms)	Current (mA)	Rset (Ohms)	Current (mA)
1	100	1800	684
100	100	2000	733
110	106	2200	780
120	111	2400	823
130	116	2700	883
150	125	3000	941
160	130	3300	993
180	138	3600	1042
200	146	3900	1085
220	155	4300	1100
240	166	4700	1100
270	176	>100,000	1100
300	190		
330	204		
360	215		
390	228		
430	245		
470	261		
510	277		
560	300		
620	318		
680	340		
750	368		
820	392		
910	422		
1000	452		
1100	485		
1200	515		
1300	545		
1500	602		
1600	632		

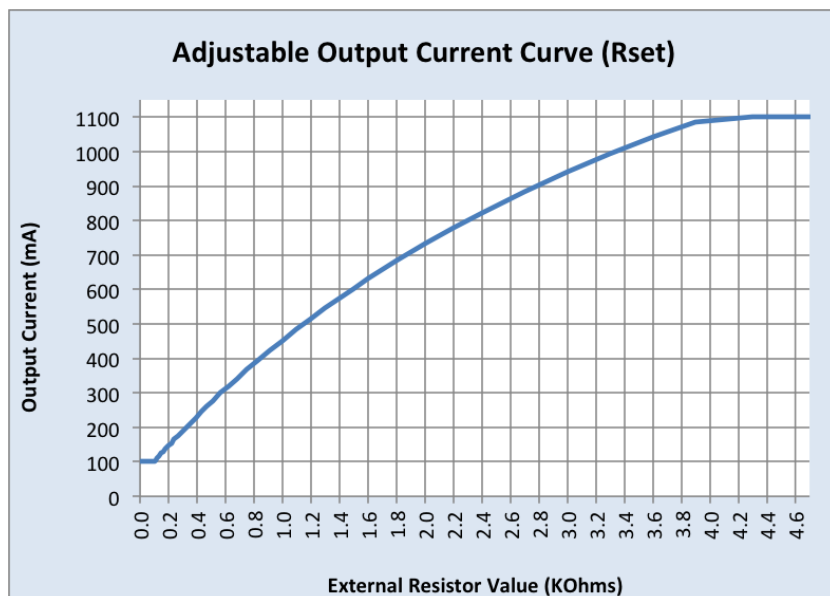

## Notes

1. There are two ways to adjust the current:
  - a. Using a resistor between Rset2 & SGND leads
    - i. Any through hole or SMD resistor with >0.25W and >20V can be used as RSET between Rset and SGND pins.
    - ii. Driver will default to 1100mA when Rset is left open.
  - b. Using SimpleSet programming (visit [www.philips.com/simpleset](http://www.philips.com/simpleset) for details)
2. The driver is by default set to Rset2.

# XITANIUM SR XI040C110V054VPT1

40W 0.10-1.1A 54V SR

## Electrical Specifications

All the specifications are typical and at 25°C Tcase unless specified otherwise.

## SR Power Supply Characteristics (Typical)

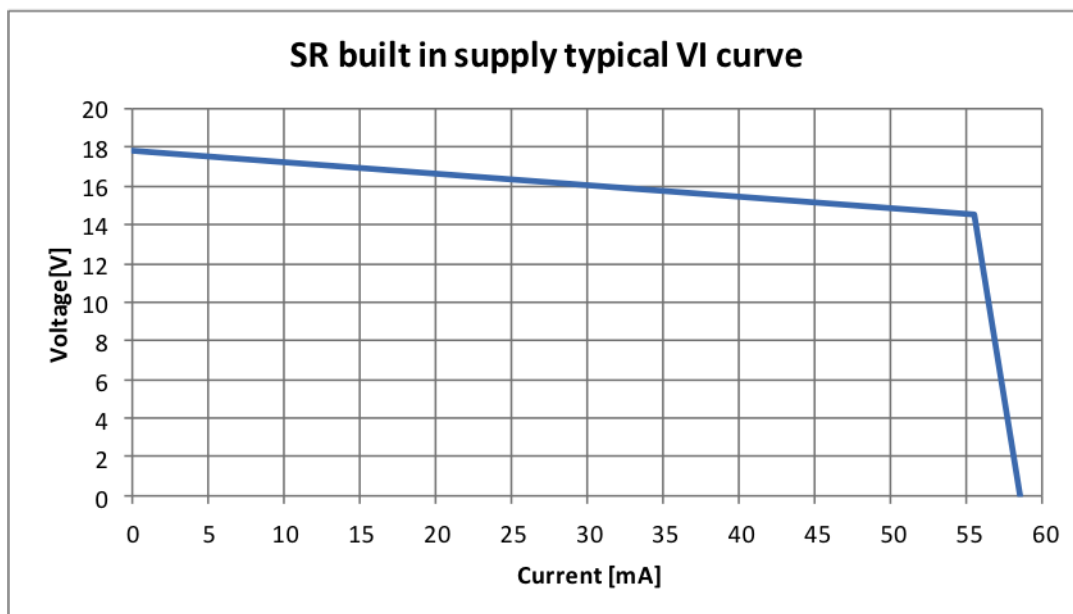

### Note:

Power supply through digital connection, default "on," for connection of one driver to one sensing/RF device. Consult your representative for use with multiple devices.

## Operating Window

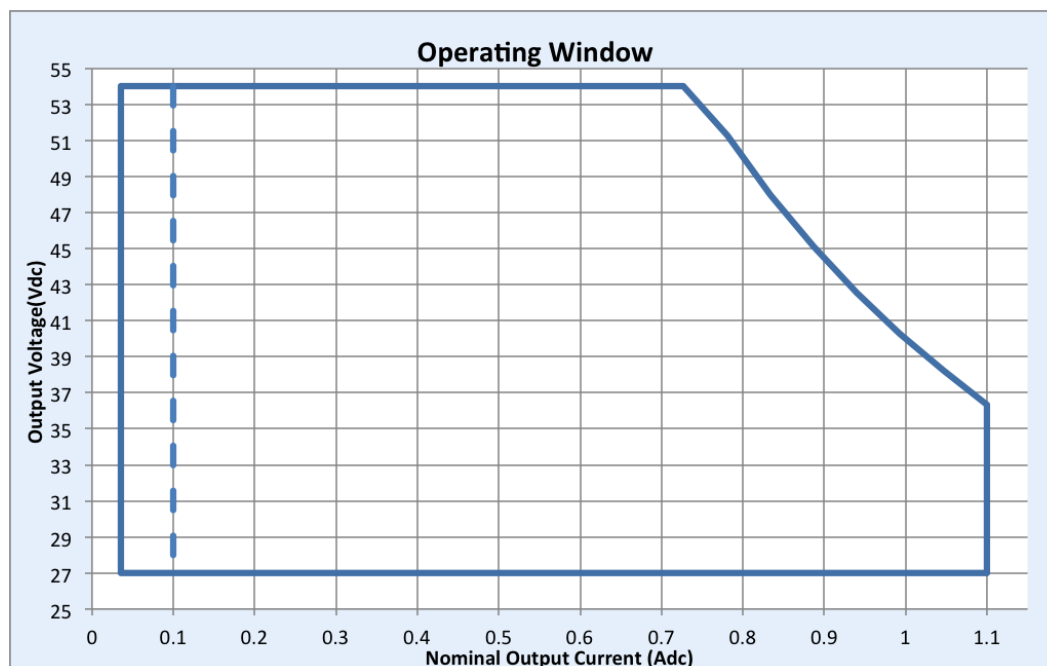

### Note:

For 5% dimming output current setting through AOC should be >0.25A.

# XITANIUM SR XI040C110V054VPT1

40W 0.10-1.1A 54V SR

## Electrical Specifications

All the specifications are typical and at 25°C Tcase unless specified otherwise.

## Dimming Characteristics

Dimming is accomplished through the 2-wire DALI connection to the sensor. DALI standard IEC62386\_102 Edition 2 defines the logarithmic dimming curve. DALI standard IEC62386\_107 Edition 1 defines the linear dimming curve as well as the command for switching between logarithmic and linear curves.

### DALI Logarithmic Dimming Curve

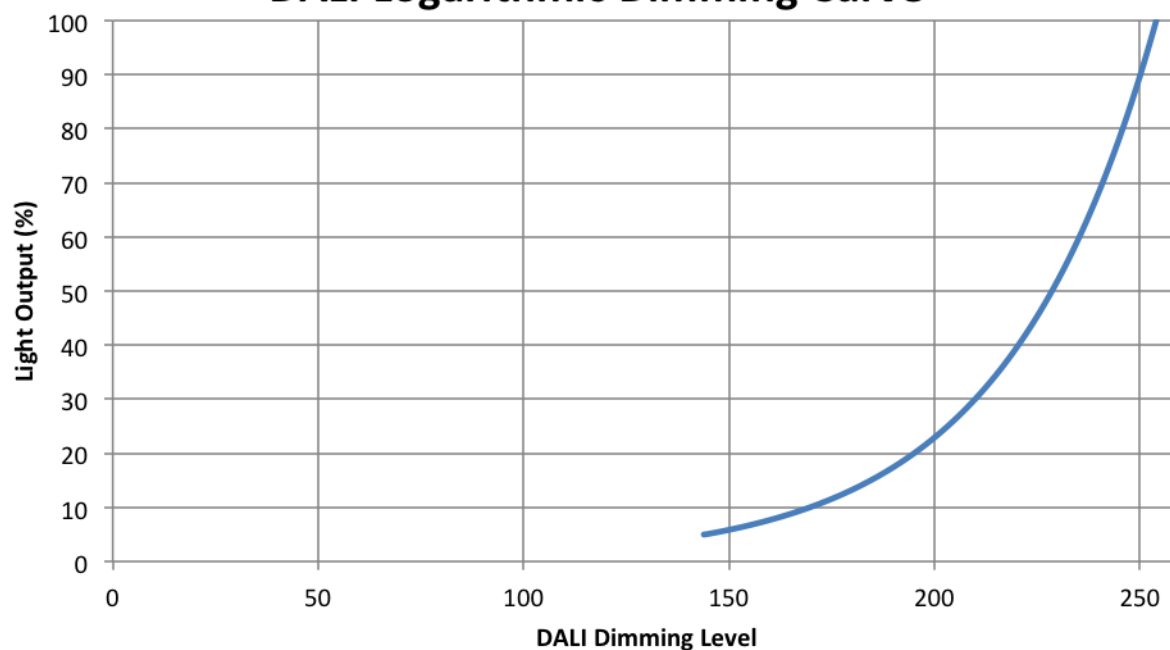

### DALI Linear Dimming Curve

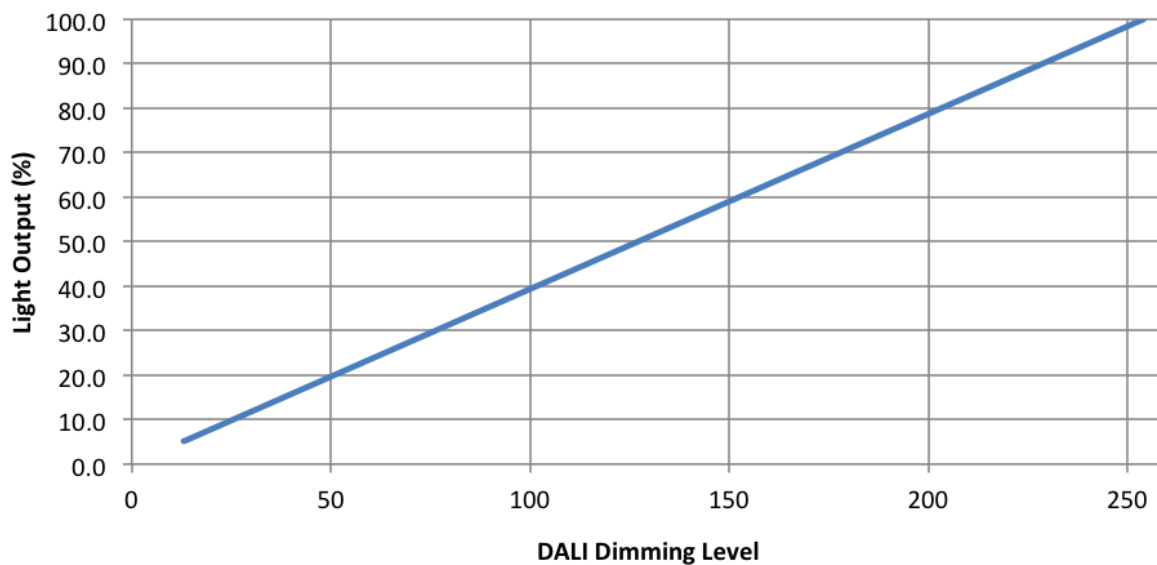

# XITANIUM SR XI040C110V054VPT1

40W 0.10-1.1A 54V SR

## Performance Characteristics

Based on measurements on a typical sample. The accuracy of the measurements is within the tolerance of the measurement instruments. The graphs are meant to be a guideline and not a specification.

### Power Factor vs. Output Power

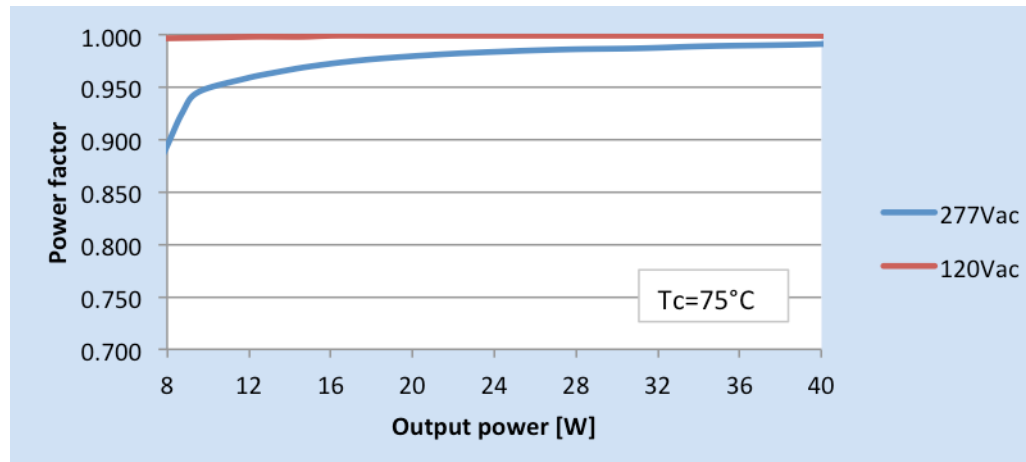

### Total Harmonic Distortion vs. Output Power

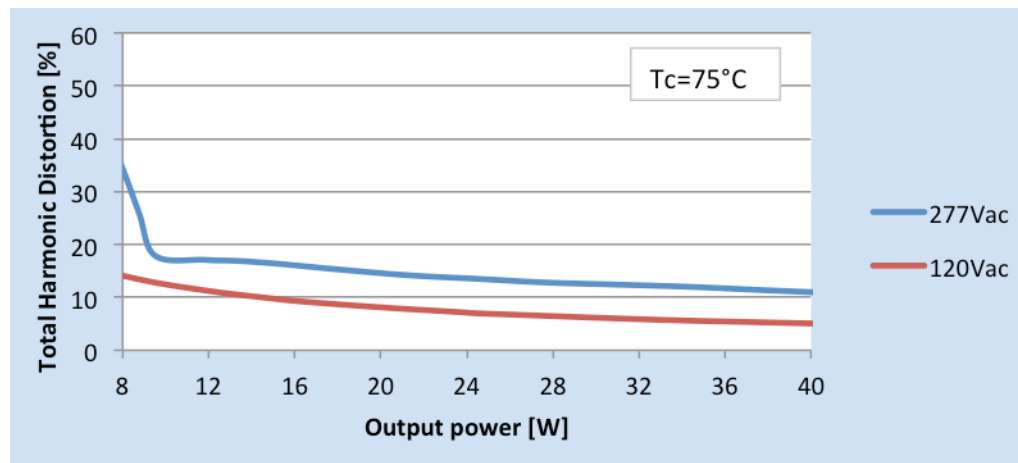

# XITANIUM SR XI040C110V054VPT1

40W 0.10-1.1A 54V SR

## Performance Characteristics

Based on measurements on a typical sample. The accuracy of the measurements is within the tolerance of the measurement instruments. The graphs are meant to be a guideline and not a specification.

### Output Current vs. Driver Case Temperature

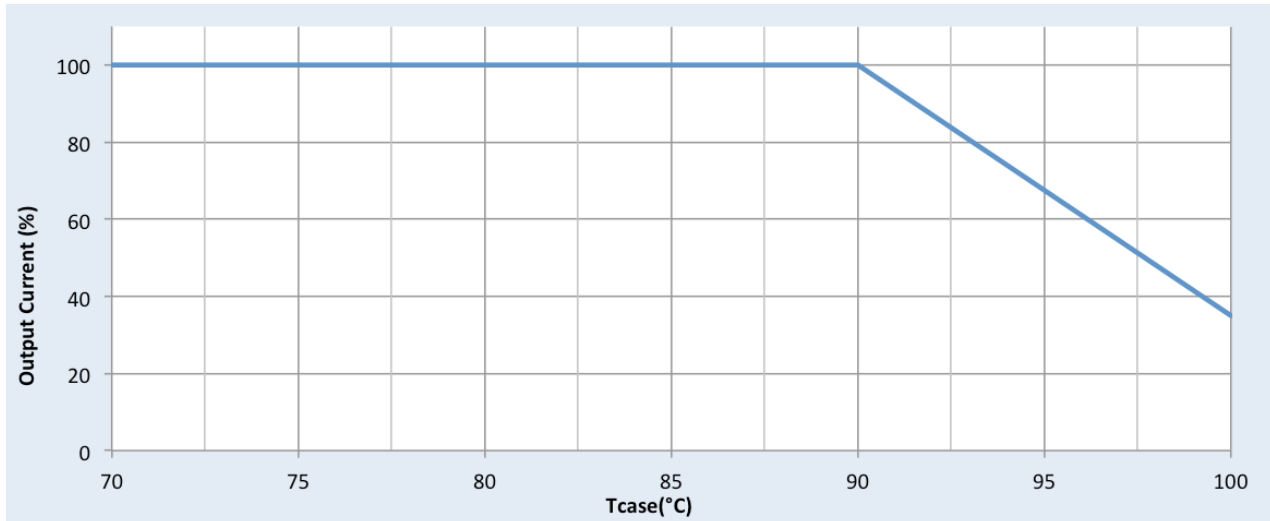

### Lifetime vs. Tcase of Driver

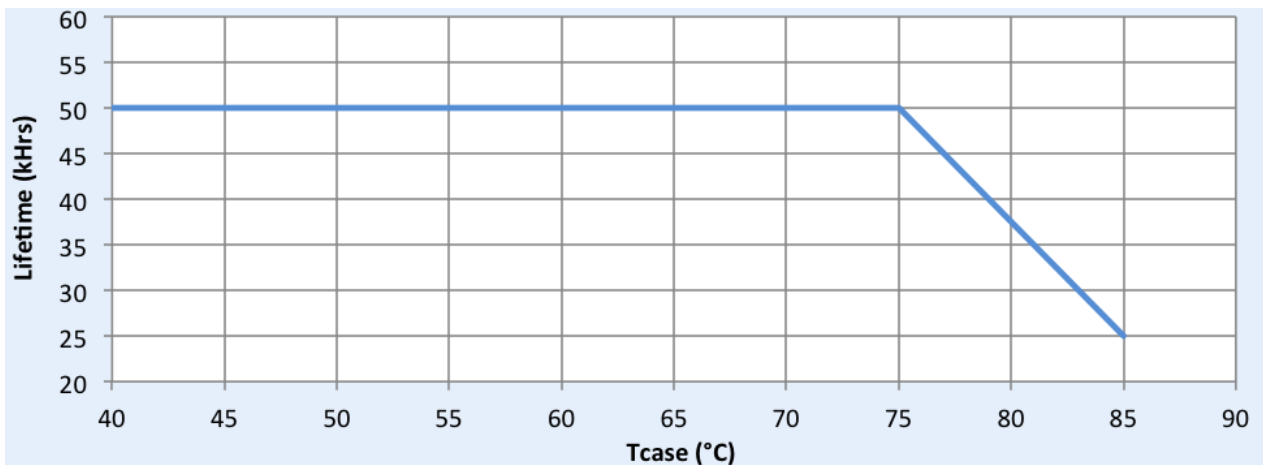

# XITANIUM SR XI040C110V054VPT1

40W 0.10-1.1A 54V SR

## Performance Characteristics

Based on measurements on a typical sample. The accuracy of the measurements is within the tolerance of the measurement instruments. The graphs are meant to be a guideline and not a specification.

## Performance Plots

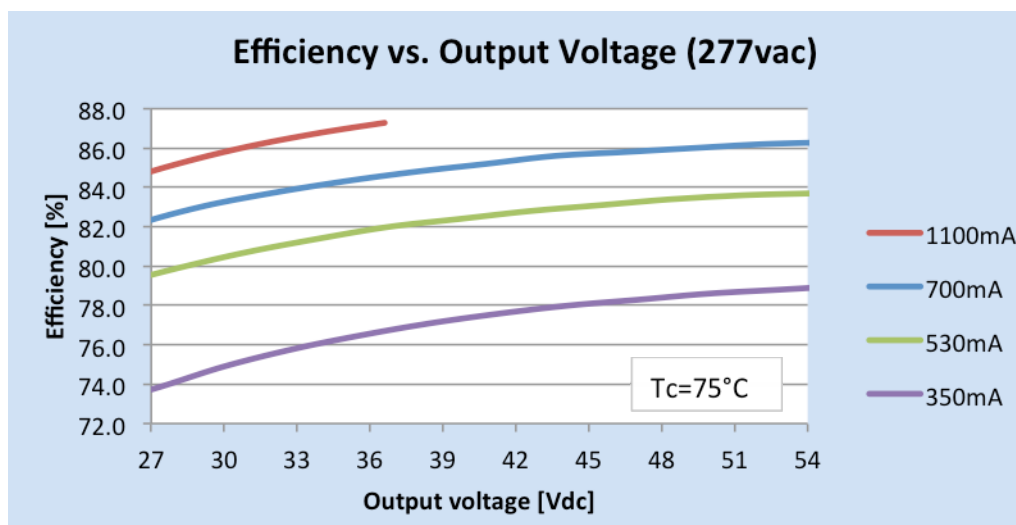
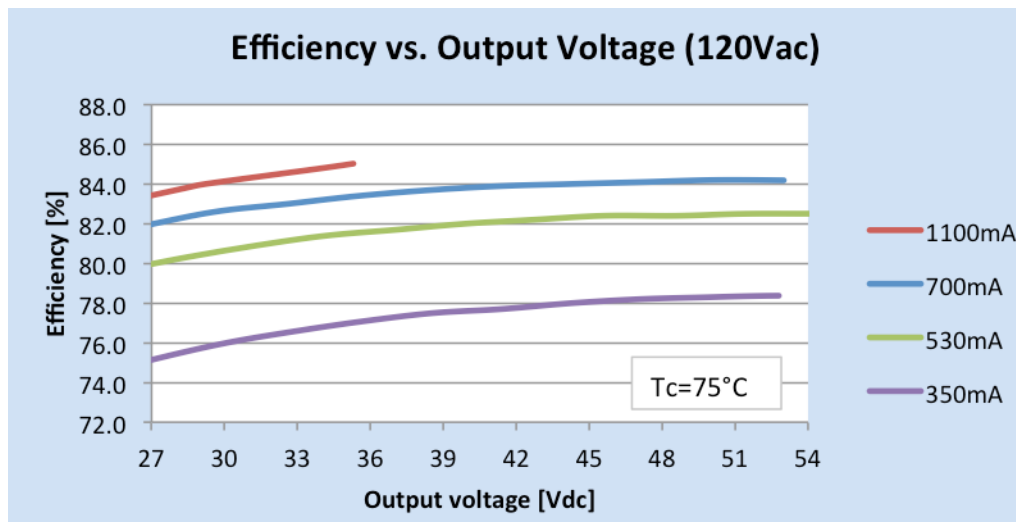



# XITANIUM SR XI040C110V054VPT1

40W 0.10-1.1A 54V SR

## Inrush Current Info

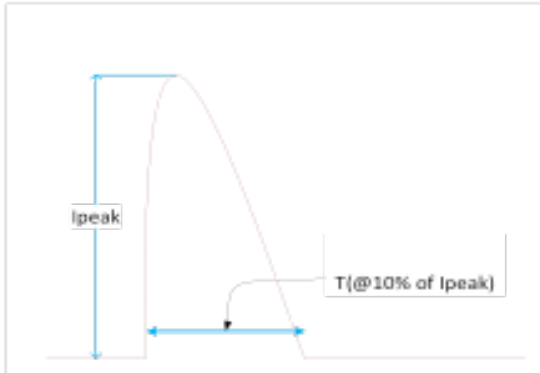

Vin	I <sub>peak</sub>	T (@ 10% of I <sub>peak</sub> )
120 Vrms	22 A	191 μs
277 Vrms	52 A	183 μs

## Lightning Surge Info

ANSI Surge Type	Differential Mode (L-N)	Common Mode (L-G, N-G, L&N-G)
100 kHz Ring Wave (w/t 30Ω)	>2.5kV	>2.5kV

## Isolation:

Isolation	Input Connectors	Output + AOC	SR Connectors	Chassis
Input Connectors	NA	2xU+1kV 1600V	2500V	2xU+1kV 1600V
Output + AOC	2xU+1kV 1600V	NA	500V	500V
SR Connectors	2500V	500V	NA	500V
Chassis	2xU+1kV 1600V	500V	500V	NA

## Installation & Application Notes

- LED driver shall be installed inside an electrical enclosure.
- Wiring inside electrical enclosure shall comply with 300V/105°C rating or higher.
- Max number of LEDs in series should not exceed 16.
- Max LED voltage should not exceed 54V under all operating conditions.
- Rset can be used to adjust output current between 100 to 1100 mA for fixed output operation.
- Driver is configured for connection to one suitably qualified sensing/RF device. Consult your representative for use with multiple devices.

## UL Conditions of Acceptability

Please contact your representative for a copy of the latest UL Conditions of Acceptability (COA).

† Restrictions on Hazardous Substances (RoHS) is a European directive (2002/95/EC) designed to limit the content of 6 substances [lead, mercury, cadmium, hexavalent chromium, polybrominated biphenyls (PBB), and polybrominated diphenyl ethers (PBDE)] in electrical and electrical products. For products used in North America, compliance with RoHS is voluntary and self-certified.



The information presented in this document is not intended as any commercial offer and does not form part of any quotation or contract.

