



Advance CertDrive Xcs LED drivers are a very cost effective option to enable CCT and Lumen selection functionality built into indoor fixtures, with proven reliability and providing optimized flexibility and SKU rationalization across the value chain.

### Specifications

Input Voltage (Vac)	Output Power (W)	Output Voltage (V)	Output Current (A)	Efficiency@ Max Load and 70°C Case	Max Case Temp. (°C)	Input Current (A)	Max. Input Power (W)	THD @ Max Load (%)	Power Factor @ Max Load	Surge Protection (Ring Wave, KV)	Envir. Protection Rating	Dimming	Dimming Range	Minimum Output Current (A)	Driver Type
120	53	28-48 Class 2 Output	0.66/0.84/1.1A	87	Life - 70°C UL - 80°C	0.51	60.9	<20%	> 0.90	2.5KV for Ring Wave	UL Dry & Damp	0-10V Analog Class 1 and 2 Wiring	10% - 100%	0.066	Constant Current
277				88		0.23									

### Enclosure

	In. (mm)	Tolerance
Overall Length (A1)	11.02 (280)	± 0.5mm
Mounting Hole Distance (A2)	10.52 (267.3)	± 0.5mm
Mounting Hole Distance (A3)	10.85 (275.6)	± 0.5mm
Case Length (A4)	8.81 (223.8)	± 0.5mm
Case Width (B1)	1.18 (30.0)	± 0.5mm
Case Height (C1)	0.83 (21.0)	± 1.0mm
Mounting Hole Diameter (D1)	0.20 (5.08)	±0.3mm
Mounting Hole Diameter (D2)	0.30 (7.7)	±0.3mm

### Wiring Diagram

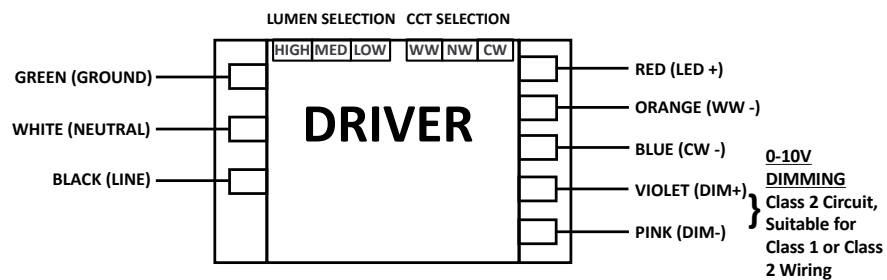

### WARNING

Install in accordance with national and local electrical codes.

The field-wiring leads or push-in terminals shall be fully enclosed.

USE ONLY WITHIN AN ENCLOSURE.  
DOIT ÊTRE INSTALLÉ DANS UNE ENCEINTE

Use 18 AWG Solid Copper Wire Rated  $\geq 90^\circ\text{C}$ .

Strip Wire 3/8".

For Class 2 Wiring, Use 20 AWG-16 AWG.

### GROUNDING

Driver case must be grounded.

### Output Current Set

High (Default)	1.1A
Med	0.84A
Low	0.66A

### CCT Set

WW (Default)
NW
CW

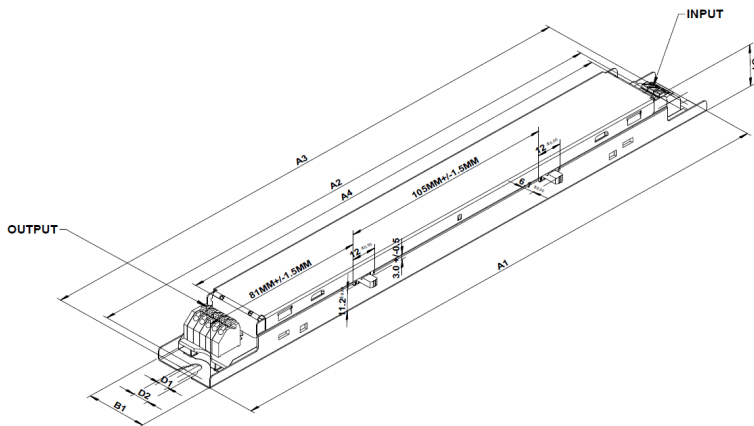

# CertaDrive CI053C110V048CCX1

53W 1.1A 48V 0-10V 120-277V

## Features

- CCT and Lumen selection 3 position Switch
  - LUMEN (High/Mid/Low)
  - CCT (WW/NW/CW)
- High Power Factor & Low THD for all positions
- 50,000 Hrs Lifetime
- Excellent Thermal Performance

## Benefits

- Allows optimized Flexibility and SKU rationalization for multiple Indoor Genral lighting application fixtures
- Performance designed to meet efficiency standards
- Option to pair with Board LED board system
- Suitable for commercial indoor applications
- Enables long life luminaire designs

## Application

- Indoor Linear troffers, wraps and suspended
- Office areas
- Educational Facilities
- Retail centers

## Electrical Specifications

All the specifications are typical and at 25°C Tcase unless specified otherwise.

## Product Data

Order Information	
Full Product Code	CI053C110V048CCX1 (Mid-Pack, 18pcs/Box), 12NC: 929002746213
Line Frequency	50/60Hz
Min. Mains Voltage Operational	108Vac
Max. Mains Voltage Operational	305Vac
Output Information	
Maximum Open Circuit Voltage	<=60Vdc
Output Current Ripple (ripple = peak to average / average)	30% max @ max lout
Output Current Tolerance (at maximum output current)	<8% <sup>2</sup>
Protections	Short Circuit, Open Circuit Protection for LED + and LED -
Features	
0-10V Dimming Interface current	100uA-250uA
Environment & Approbation	
Operating Ambient Temp. Range	-20°C to +40°C
Max Case Temperature (Tcase)	70°C for Life & 80°C for UL Safety
Agency Approbations	UL, CUL, NOM, FCC, Class P (UL, CUL)
Electromagnetic Compliance	FCC Title 47 Part 15 Class A for 120Vac - 277Vac
Audible Noise	<24dB Class A
Weight	0.463Lbs / 0.210kgs

1. Philips Advance CertaDrive XCS LED Drivers are manufactured to engineering standards correlating to a designed and average life expectancy of 50,000 hours of operation at maximum rated case temperature. Minimum 90% survivals based on MTTF modeling.
2. Note: power factor (PF) and total harmonic distortion (THD) may deviate under adverse mains voltage conditions outside nominal operation. Output current (I out) variation includes effects of line and load regulation, temperature variation and component tolerances.

# CertaDrive CI053C110V048CCX1

53W 1.1A 48V 0-10V 120-277V

## Electrical Specifications

All the specifications are typical and at 25°C Tcase unless specified otherwise.

### I<sub>out</sub> Vs. V<sub>out</sub>

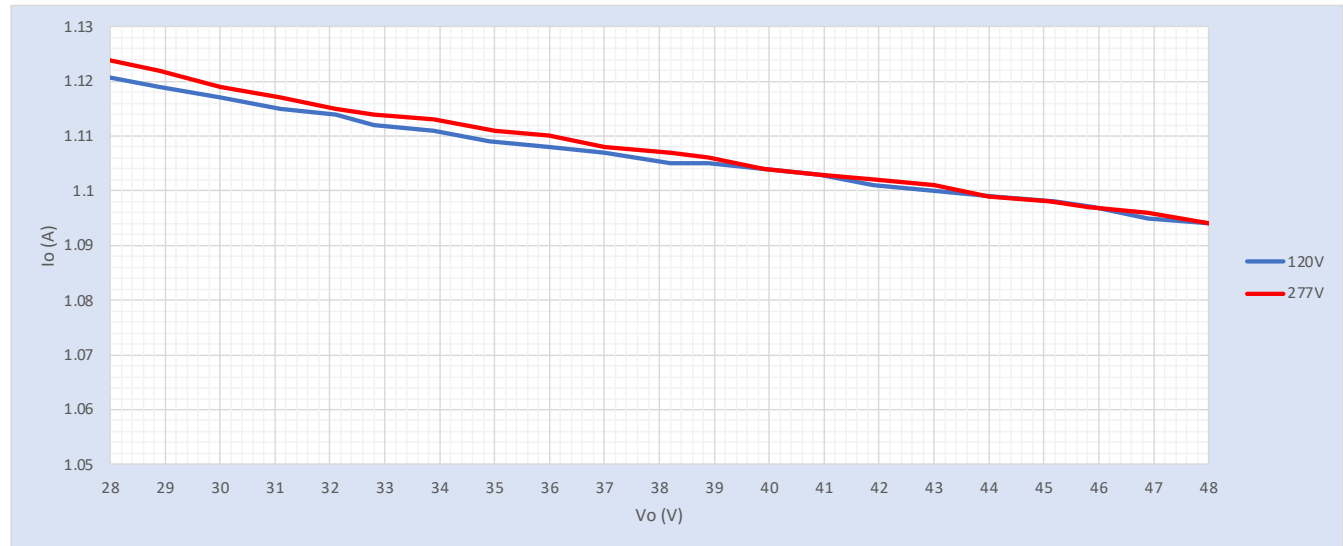

### Notes

1. Factory default output current is 1.1A.

# CertaDrive CI053C110V048CCX1

53W 1.1A 48V 0-10V 120-277V

## Electrical Specifications

All the specifications are typical and at 25°C Tcase unless specified otherwise.

## 0-10V Dimming Interface

Dimming source current from the driver: 100-250µA

Minimum Dim Level: 10% of Iout

Maximum output voltage on the dimming wires: 12V

Leakage current of dimming leads 0.01mA, recommended max number of control circuits in parallel refer to Design-In Guide

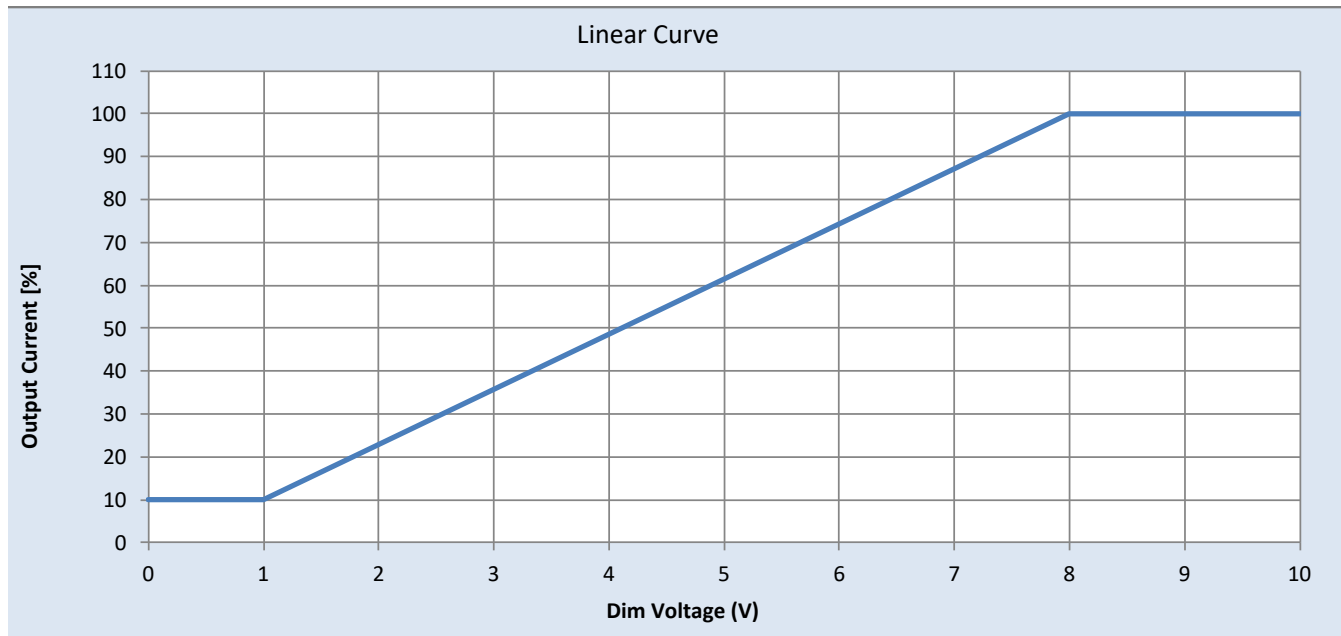

## Approved Dimmer List

Manufacturer	Manufacturer Part Number
Lutron	Visit <a href="http://www.lutron.com/">www.lutron.com/</a> advance for a list of dimmers (Mark VII) that will work with this driver
Leviton	IllumaTech IP7 series
Philips	Sunrise - SR1200ZTUNV

# CertaDrive CI053C110V048CCX1

53W 1.1A 48V 0-10V 120-277V

## Electrical Specifications

All the specifications are typical and at 25°C Tcase unless specified otherwise.

### Output Current Vs. Driver Case Temperature

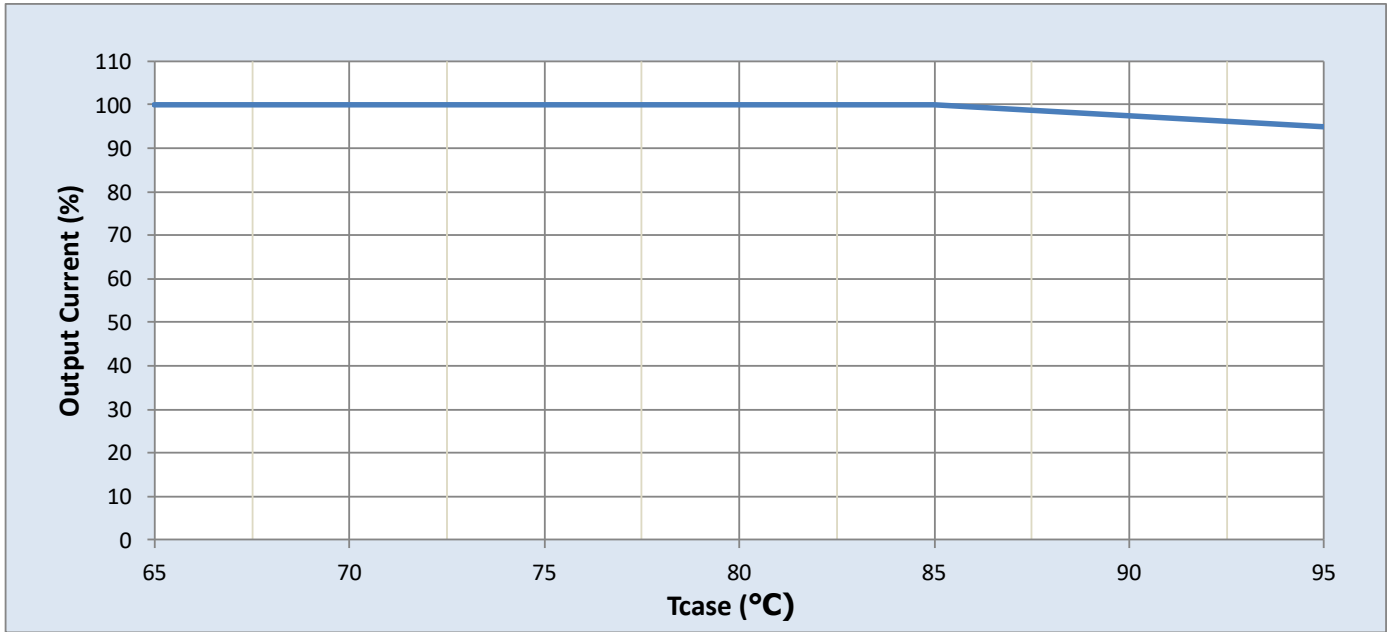

Note: There is  $\pm 5^\circ\text{C}$  tolerance on the driver case temperature.

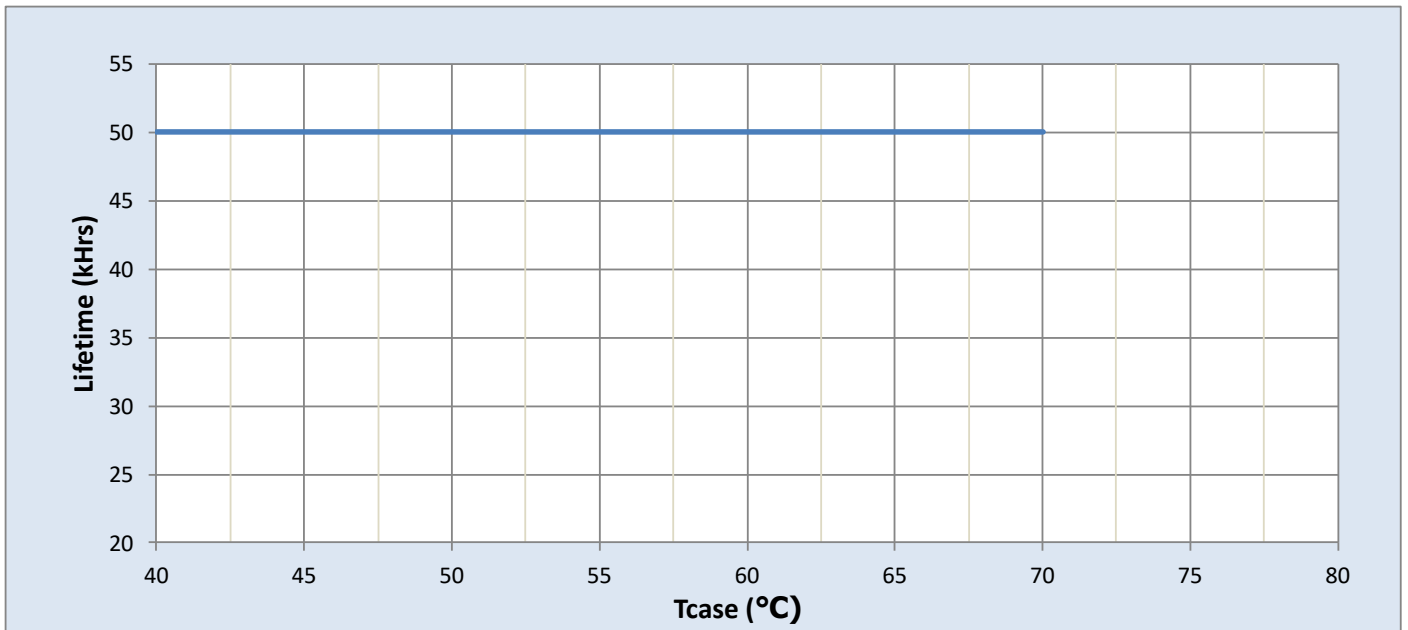

# CertaDrive CI053C110V048CCX1

53W 1.1A 48V 0-10V 120-277V

## Performance Characteristics

Based on measurements on a typical sample at 70°C case. The accuracy of the measurements is within the tolerance of the measurement instruments.

### Efficiency Vs. Output Voltage at 120Vac Input

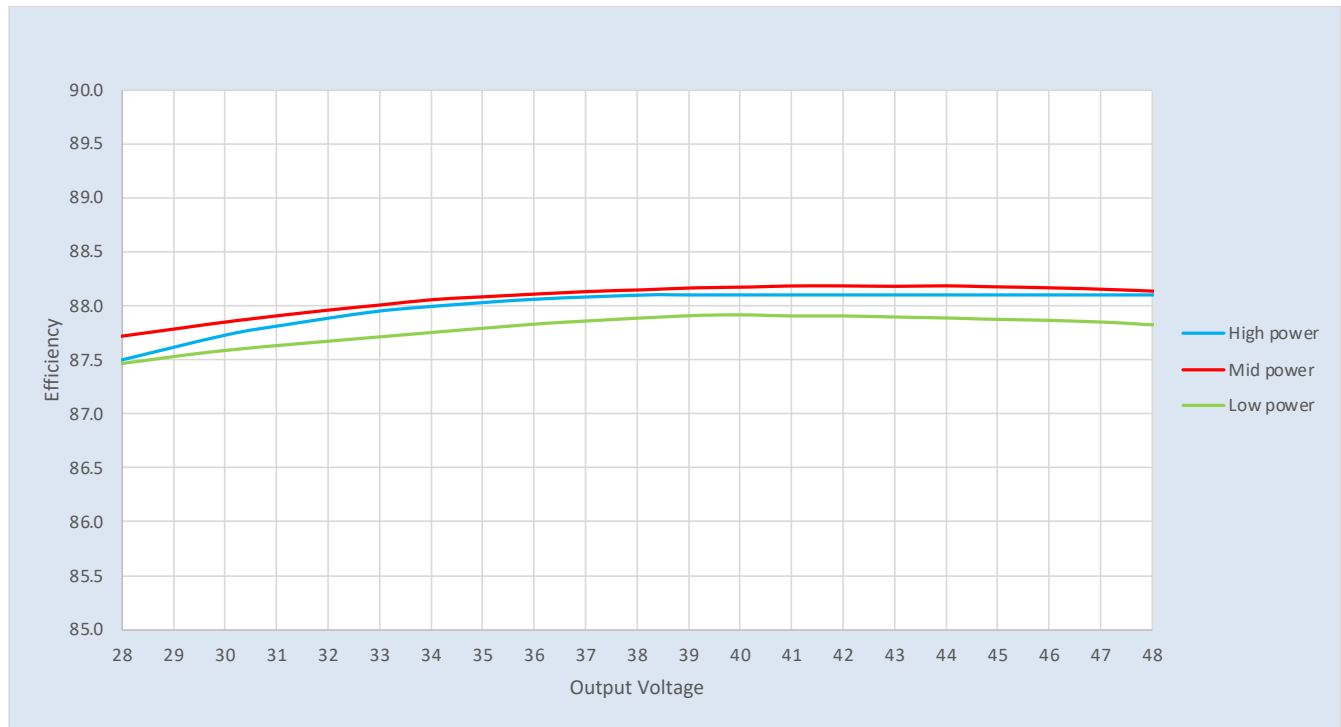

### Efficiency Vs. Output Voltage at 277Vac Input

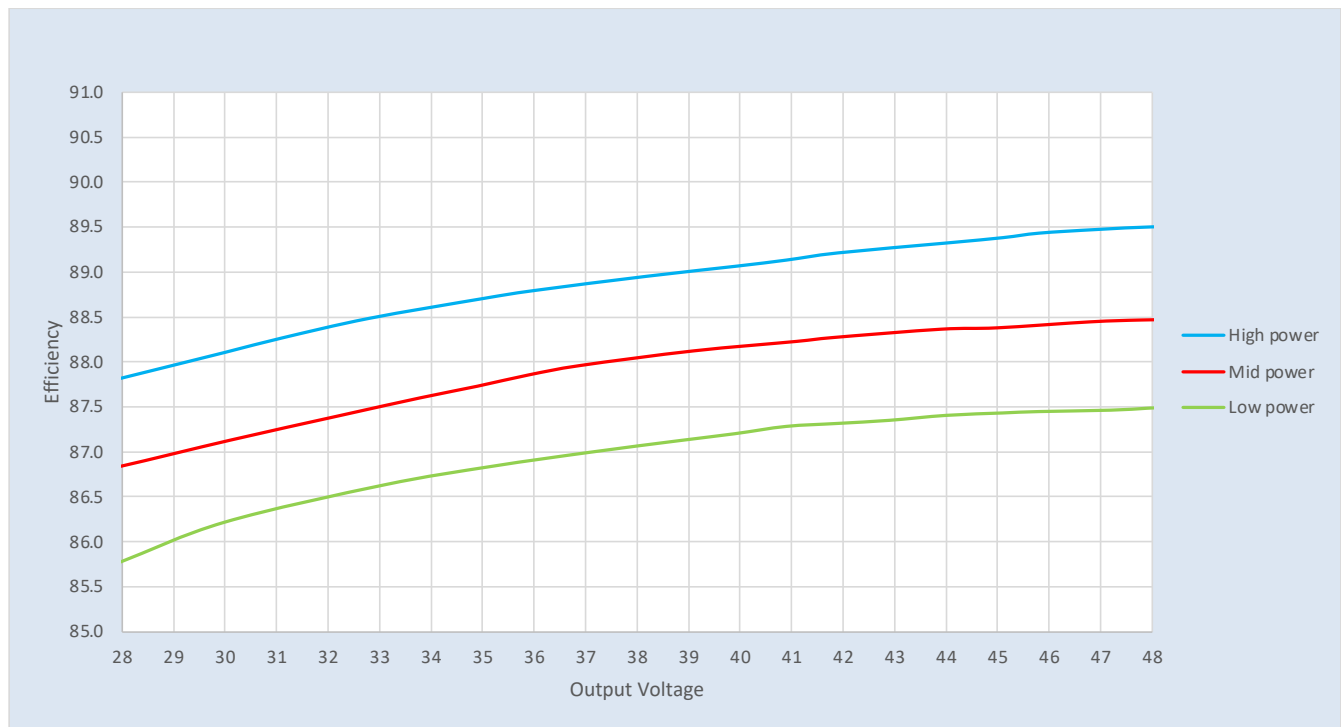

# CertaDrive CI053C110V048CCX1

53W 1.1A 48V 0-10V 120-277V

## Performance Characteristics

Based on measurements on a typical sample at 80°C case. The accuracy of the measurements is within the tolerance of the measurement instruments.

### Power Factor Vs. Output Power

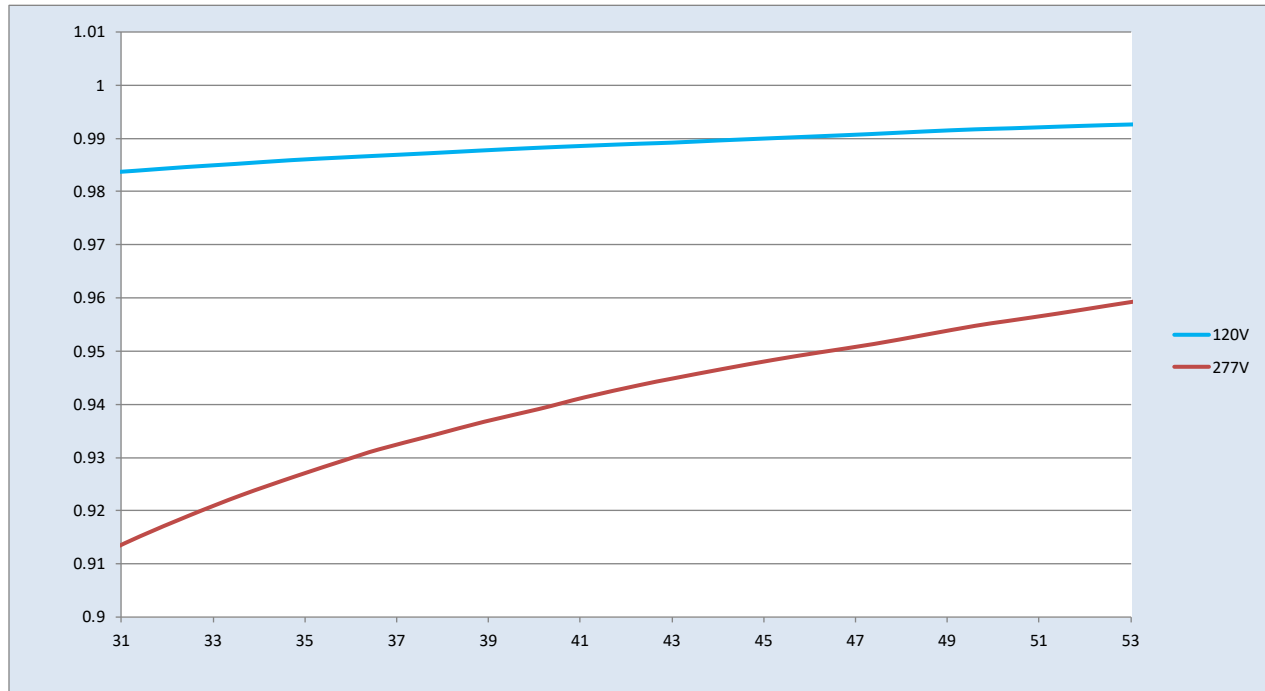

### Total Harmonic Distortion (THD) Vs. Output Power

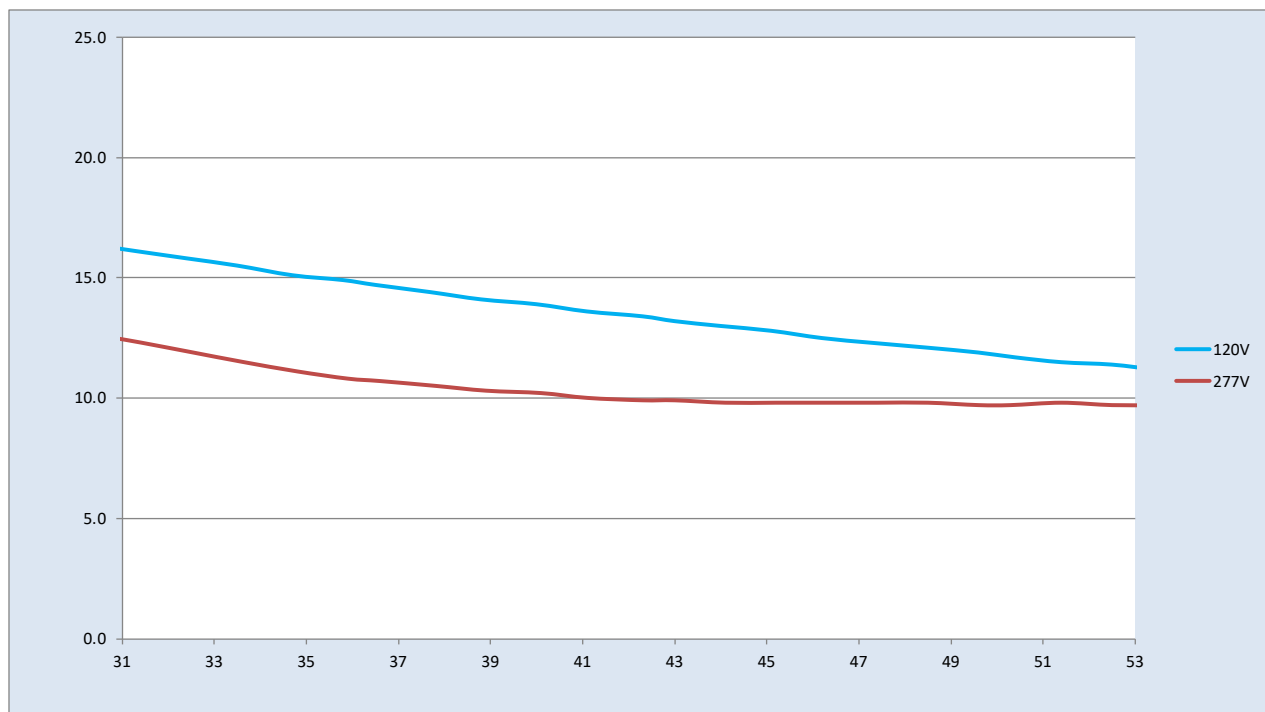

# CertaDrive CI053C110V048CCX1

53W 1.1A 48V 0-10V 120-277V

## Inrush Current Info

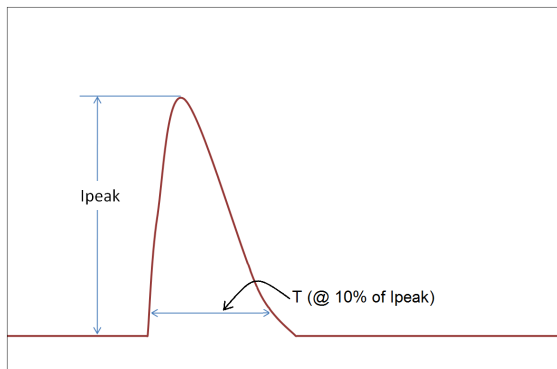

Vin	Ipeak	T (@ 10% of Ipeak)
120 Vrms	13.3A	10.64μS
277 Vrms	33.3A	10.26μS

Inrush current is measured at peak of the corresponding line voltage. Source impedance per NEMA 410.

## Lightning Surge Info

ANSI Surge Type	Differential Mode (L-N)	Common Mode (L-G, N-G, L&N-G)
100 kHz Ring Wave (w/t 30Ω)	2.5kV	2.5kV

## Isolation

Isolation	Input	Output	0-10V	Enclosure
Input	NA	2xU+1kV	2xU+1kV	2xU+1kV
Output	2xU+1kV	NA	2xU+1kV	500
0-10V	2xU+1kV	2xU+1kV	NA	2xU+1kV
Enclosure	2xU+1kV	500	2xU+1kV	NA

U = Max input voltage



© 2022 Signify Holding. All rights reserved. The information provided herein is subject to change, without notice. Signify does not give any representation or warranty as to the accuracy or completeness of the information included herein and shall not be liable for any action in reliance thereon. The information presented in this document is not intended as any commercial offer and does not form part of any quotation or contract, unless otherwise agreed by Signify.

Signify North America Corporation  
400 Crossing Blvd, Suite 600  
Bridgewater, NJ 08807  
Telephone: 855-486-2216

Signify Canada Ltd.  
281 Hillmount Road,  
Markham, ON, Canada L6C 2S3  
Telephone: 800-668-9008

All trademarks are owned by Signify Holding or their respective owners.